

60° Asymmetrical Beam Antenna

HORN ANTENNA WITH TWISTPORT™ CONNECTOR

60° Asymmetrical Horn TP Antenna combines the best of both worlds - high gain of a traditional sector antenna and zero side lobes of a horn. Its radiation pattern is wide in azimuthal and narrow in elevation plane, greatly improving coverage planning options. 60° Asymmetrical Horn TP Antenna exceeds the traditional patch sector antenna thanks to high stability of gain and radiation pattern in the whole band of operation. Outstanding noise rejection and precision of radiation pattern favors 60° Asymmetrical Horn TP antenna for high-density AP clusters, in highly populated areas and dense co-location sites.

HG3-TP-A60 features our revolutionary TwistPort™ connector, a patent-pending twist-and-lock waveguide port. TwistPort™ is virtually lossless and embodies a complete shift of paradigm in wireless network scalability and convenience of deployment. 60° Asymmetrical Horn TP Antenna supports a wide range of third party mainstream radios with our TPA TwistPort™ Adaptor.



TECHNICAL DATA

Antenna Connection	TwistPort™ - Quick Locking Waveguide Port
Antenna Type	Horn
Materials	UV Resistant ABS Plastic, Polycarbonate, HDPE, Aluminium, Stainless Steel
Environmental	IP55
Pole Mounting Diameter	22-80 mm
Temperature	-35°C to +55°C (-31°F to +131°F)
Wind Survival	160 km/hour
Mechanical Adjustment	± 25° Elevation, ± 20° Azimuth
Weight	4.8 Kg / 10.5 lbs – single unit* 6.5 Kg / 14.3 lbs – single unit incl. package*
Single Unit	Retail Box: 51.5 × 37.0 × 14.0 cm*

PRODUCT DIMENSIONS

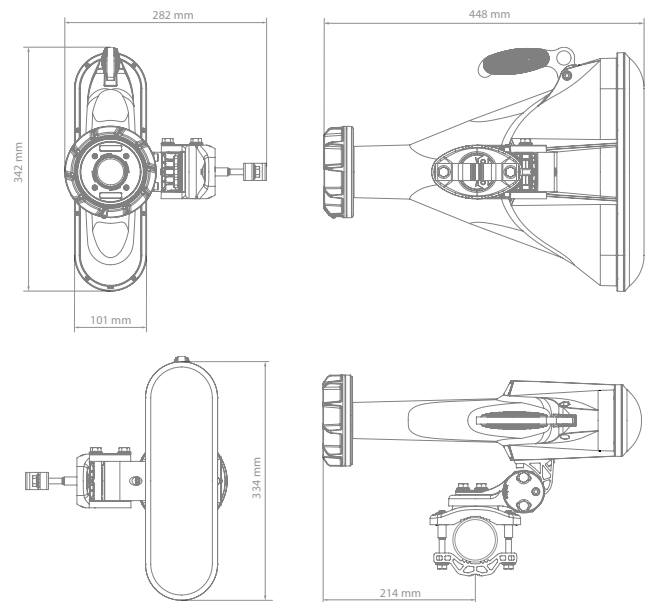

PERFORMANCE

Frequency Range	5180 - 6000 MHz
Gain	17 dBi
Azimuth Beam Width -3 dB	H 45° / V 42°
Elevation Beam Width -3 dB	H 17° / V 16°
Azimuth Beam Width -6 dB	H 60° / V 60°
Elevation Beam Width -6 dB	H 25° / V 25°
Front-to-Back Ratio	27 dB

AZIMUTH PATTERN



ELEVATION PATTERN

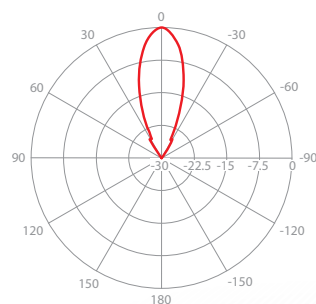

GAIN

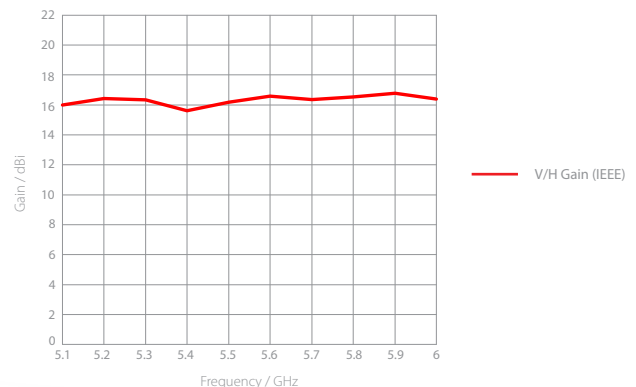

*Subject to change